

# Load Rating Chart

***Model 2277S***



© Manitex 2000

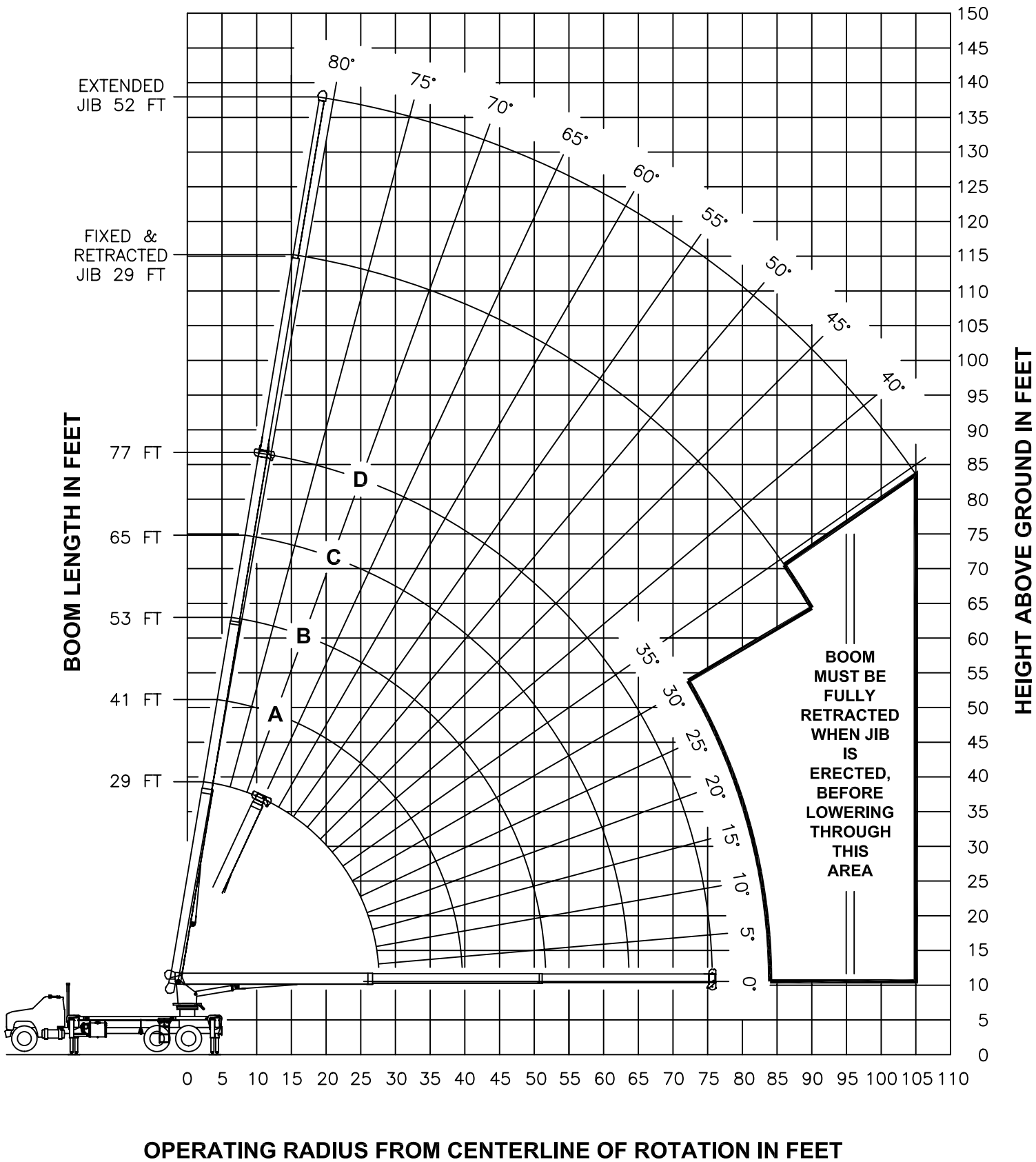

**NOTE:** Additional copies of this Load Rating Chart can be purchased from your Manitex Distributor. When ordering, use the part number shown in the bottom left corner of this page.

# RANGE DIAGRAM

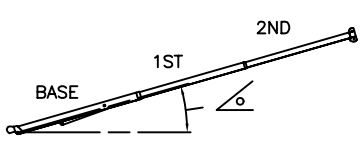

## LOAD RATINGS WITH OUTRIGGERS FULLY EXTENDED AND SET WITH MACHINE LEVELLED

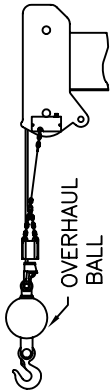
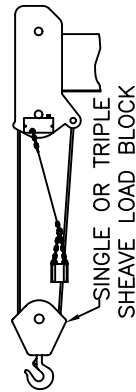
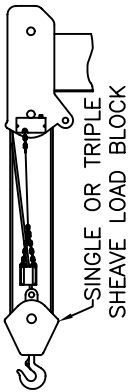
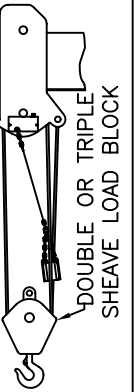
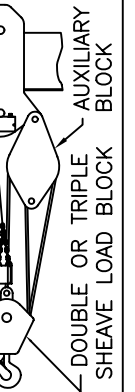
MAIN BOOM LOAD RATINGS IN LBS										JIB LOAD RATINGS IN LBS						
OPERATING RADIUS	LOADED BOOM ANGLE		BOOM LENGTH AND MARKER							OPERATING RADIUS	LOADED BOOM ANGLE	29 FT JIB FOR ALL BOOM LENGTHS SEE WARNING NOTE 4		52 FT JIB FOR ALL BOOM LENGTHS SEE WARNING NOTE 4		
	°	29 FT	°	41 FT								°	53 FT	°	65 FT	°
5	80	44000														
8	74	29600														
10	69	24870	76	22000							10					
12	65	21510	73	20160	78	16490					12					
14	60	18960	70	17710	75	14390	79	13860			14					
17	53	16080	66	15010	72	12070	76	11580	79	11500	17					
20	45	13830	61	13010	69	10390	73	9930	77	9560	20					
25	27	10490	52	10600	63	8410	69	8000	73	7670	25	79	4820			
30			42	8770	56	7010	64	6660	69	6350	30	77	4270	80	3000	
35			30	7120	49	5930	59	5650	65	5390	35	74	3790	78	2900	
40					41	5030	53	4860	61	4640	40	71	3330	76	2640	
45					31	4170	47	4210	56	4030	45	68	2900	74	2410	
50					17	3070	40	3630	51	3530	50	65	2540	71	2200	
55							33	3070	46	3080	55	62	2220	69	2020	
60							22	2410	40	2680	60	59	1940	67	1840	
65									34	2280	65	55	1660	64	1670	
70									25	1840	70	51	1400	61	1510	
75									13	1220	75	47	1170	58	1350	
80											80	43	960	55	1200	
85											85	39	760	52	1060	
90											90	34	560	49	940	
95											95			46	790	
100											100			43	650	
105											105			39	510	
		680 LBS.	480 LBS.		370 LBS.		300 LBS.		260 LBS.		DEDUCTIONS FOR STOWED JIB					

ALLOWABLE LINE PULL						WARNING
1 PART LINE	2 PART LINE	3 PART LINE	4 PART LINE	5 PART LINE	6 PART LINE	
						<p>ANTI-TWO-BLOCK SYSTEM MUST BE IN GOOD OPERATING CONDITION BEFORE OPERATING CRANE. REFER TO OWNER'S MANUAL.</p> <p>KEEP AT LEAST 3 WRAPS OF LOAD LINE ON DRUM AT ALL TIMES.</p>
8500 LBS	17000 LBS	25500 LBS	34000 LBS	42500 LBS	44000 LBS	
7400 LBS	14800 LBS	22200 LBS	29600 LBS	37000 LBS	44000 LBS	<p>9/16" - 6X25 IWRC (3.5:1 S.F.) 29750 LBS. BREAKING STRENGTH</p> <p>9/16" ROT RESISTANT (5.0:1 S.F.) 37000 LBS. BREAKING STRENGTH</p>

## AREA OF OPERATION

### WARNING:

THE FRONT TIRES MUST BE IN CONTACT WITH THE GROUND, AND THE MACHINE LEVEL, WHEN OPERATING IN THIS AREA.

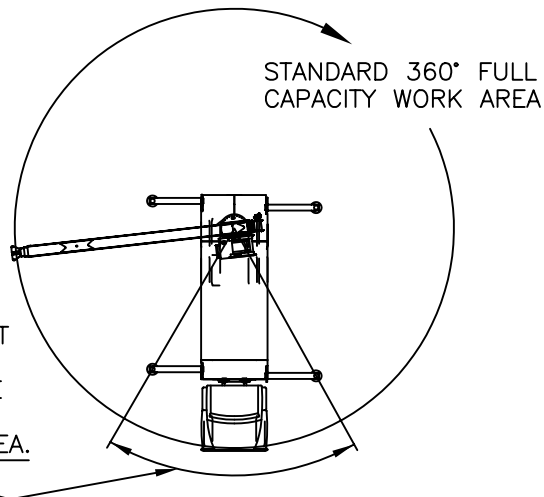

## DEDUCTIONS FROM RATED LOADS FOR LOAD HANDLING DEVICES SUPPLIED BY MANITOWOC BOOM TRUCKS, INC.

AUXILIARY BLOCK — — — — — 50 LBS  
 OVERHAUL BALL — — — — — SEE OVERHAUL BALL MANUFACTURER NAMEPLATE  
 LOAD BLOCK — — — — — SEE BLOCK MANUFACTURER NAMEPLATE  
 HOSE REEL — — — — — 160 LBS  
 SWING AROUND JIB — — — — — SEE LOAD CHART

## **WARNING**

1. THE OPERATOR MUST READ AND UNDERSTAND THE OWNER'S MANUAL BEFORE OPERATING THIS CRANE.
2. POSITIONING OR OPERATION OF CRANE BEYOND AREAS SHOWN ON THIS CHART IS NOT INTENDED OR APPROVED EXCEPT WHERE SPECIFIED IN OWNER'S MANUAL.
3. LOADED BOOM ANGLES AT SPECIFIED BOOM LENGTHS GIVE ONLY AN APPROXIMATION OF THE OPERATING RADIUS. THE BOOM ANGLE BEFORE LOADING SHOULD BE GREATER TO ACCOUNT FOR DEFLECTIONS. DO NOT EXCEED THE OPERATING RADIUS FOR RATED LOADS.
4. THE OPERATING RADIUS SHOWN IN THE JIB RATING CHART IS FOR FULLY EXTENDED BOOM ONLY. WHEN BOOM IS NOT FULLY EXTENDED, USE ONLY LOADED BOOM ANGLE TO DETERMINE LOAD RATING OF JIB. DO NOT RELY ON THE CAPACITY ALERT SYSTEM WHEN LIFTING FROM JIB.
5. FOR BOOM ANGLES NOT SHOWN ON JIB LOAD RATING CHART, USE RATING OF NEXT LOWER BOOM ANGLE.
6. FOR BOOM LENGTHS NOT SHOWN, USE RATING OF NEXT SHORTER OR LONGER BOOM LENGTH, WHICHEVER IS LESS. FOR RADII NOT SHOWN, USE RATING OF NEXT LONGER RADIUS.
7. CRANE LOAD RATINGS ON OUTRIGGERS ARE BASED ON FREELY SUSPENDED LOADS WITH THE MACHINE LEVELED AND STANDING ON A FIRM UNIFORM SUPPORTING SURFACE. NO ATTEMPT SHALL BE MADE TO MOVE A LOAD HORIZONTALLY ON THE GROUND IN ANY DIRECTION.

## **WARNING (CONTINUED)**

8. PRACTICAL WORKING LOADS DEPEND ON SUPPORTING SURFACE, WIND, AND OTHER FACTORS AFFECTING STABILITY SUCH AS HAZARDOUS SURROUNDINGS, EXPERIENCE OF PERSONNEL, AND PROPER HANDLING, ALL OF WHICH MUST BE TAKEN INTO ACCOUNT BY THE OPERATOR.
9. THE MAXIMUM LOAD WHICH MAY BE TELESCOPED IS LIMITED BY HYDRAULIC PRESSURE, BOOM ANGLE, AND BOOM LUBRICATION. IT IS SAFE TO ATTEMPT TO TELESCOPE ANY LOAD WITHIN THE LIMITS OF THE LOAD RATING CHART.
10. LIFTING OFF THE MAIN BOOM POINT WHILE THE SWING AROUND JIB IS ERECTED IS NOT INTENDED OR APPROVED.

## **INFORMATION**

1. DEDUCTIONS MUST BE MADE FROM RATED LOADS FOR STOWED JIB, OPTIONAL ATTACHMENTS, HOOKS, AND LOADBLOCKS (SEE DEDUCTION CHART). WEIGHTS OF SLINGS AND ALL OTHER LOAD HANDLING DEVICES SHALL BE CONSIDERED A PART OF THE LOAD.
2. CRANE LOAD RATINGS ARE BASED ON OUTRIGGERS FULLY EXTENDED AND SET WITH THE MACHINE LEVELED.
3. LOAD RATINGS ABOVE THE HEAVY LINE ARE STRUCTURALLY LIMITED CAPACITIES. LOAD RATINGS BELOW THE HEAVY LINE ARE STABILITY LIMITED CAPACITIES AND DO NOT EXCEED 85% OF TIPPING.

## **DEFINITIONS**

1. OPERATING RADIUS IS THE HORIZONTAL DISTANCE FROM THE AXIS OF ROTATION TO THE CENTER OF THE VERTICAL HOIST LINE OR TACKLE WITH LOAD APPLIED.
2. LOADED BOOM ANGLE AS SHOWN IN THE COLUMN HEADED BY , IS THE INCLUDED ANGLE BETWEEN THE HORIZONTAL AND LONGITUDINAL AXES OF THE BOOM BASE AFTER LIFTING RATED LOAD AT RATED RADIUS.