

SCD15 Product Guide

ASME B30.5
Imperial 85%



Features

- 13,6 t (15 USt) capacity
- 12,5 m (41 ft) three-section full-power boom
- 8,1 t (9 USt) deck carrying ability
- Load sensing hydraulic piston pump
- Mechanical lever proportional controls
- Dual fuel and diesel engine options available

SHUTTLELIFT SCD15

The new SCD15 is a 13,6 t (15 USt) capacity carrydeck crane, offering a three-section 12,5 m (41 ft) boom, two-wheel drive/four-wheel steer capability. It also has a three-position pivoting boom head for low head room clearance and oblique-style outriggers with nylatron outrigger wear pads.

Features

> Operator focused design

The SCD15 is designed with the operator in mind. A storage tray and main storage box are located in the front center of the carrier and are suitable for storing the downhaul ball or hook blocks available on this model. Stow rigging equipment in a storage box located on the right hand side of the machine. This compartment has a latched door to prevent accidental opening when machine is in operation. The SCD15 also includes a full LED lighting package (improved visibility and longer lasting).

> Operator cab

Simple operator cab features direct-to-valve hydraulic controls, ergonomically laid out fixed steering wheel and easy-to-set up graphical Rated Capacity Limiter (RCL) system. The cab is up to 4.8" wider providing additional operator comfort. The optional enclosed cab includes a split cab door with sliding glass window for enhanced operator comfort.

> Pivoting boom nose

Ideal for operating in confined spaces, the three-position mechanically offset (0°, 40° and 80°) pivoting boom nose lowers boom nose head height by 0,36 m (14 in).

> Options

- Convenience package includes pintle hitches and light grilles
- Lighting package includes amber strobe light and boom-mounted work lights
- Below-deck winch
- Air-conditioning

> Customized Lift Solution Options

Standard options may not always meet the job requirements. Consult your local dealer for a Lift Solution quote for customized options, such as:

- Non-marking tires
- Oil cooler
- Barge charts
- External light bar
- Spark arrestor



SCD15 benefits

- EPA Tier 4 Final emissions compliant without the use of a SCR or UREA injected DEF system. No Diesel Exhaust Fluid (DEF) required.
- The SCD15 includes many easy to operate features such as mechanical lever proportional controls, independently controlled single-stage oblique outriggers and a simple to operate RCL system.
- An optional 5,3 m - 15,2 m (17.3 ft - 50 ft) four-section, full-power main boom and a 4,6 m (15 ft) fixed swingaway extension are available to offer higher reach.
- Customer focused design with more operator comfort in the cab and storage for the downhaul and headache ball on the machine.



What you need, when you need it.

Get right to work with the right equipment — Manitowoc Finance gives you access to flexible, affordable financing you can use to seize profitable new opportunities as they arise.

Feel confident in your investment — rest easy with the assurance of the world's most advanced crane service and support network.

Table of contents

Dimensions and weights	5
Working range and load charts - 41 ft boom (Imperial 85%)	7
Working range and load charts - 50 ft boom (Imperial 85%)	11
Transportation and lifting data	15
Load handling	16
Specifications.....	17
Symbols glossary.....	19

Dimensions and weights

Dimensions										
Tire size	A	B	C	D	E	A	B	C	D	E
385/65 D22.5	7307 mm (287.7 in)	5939 mm (233.8 in)	5526 mm (217.6 in)	5318 mm (209.4 in)	2647 mm (104.2 in)	5210 mm (205.1 in)	3606 mm (142.0 in)	3175 mm (125 in)	2856 mm (112.4 in)	2068 mm (81.4 in)
	Two-wheel steer (radius)					Four-wheel steer (radius)				

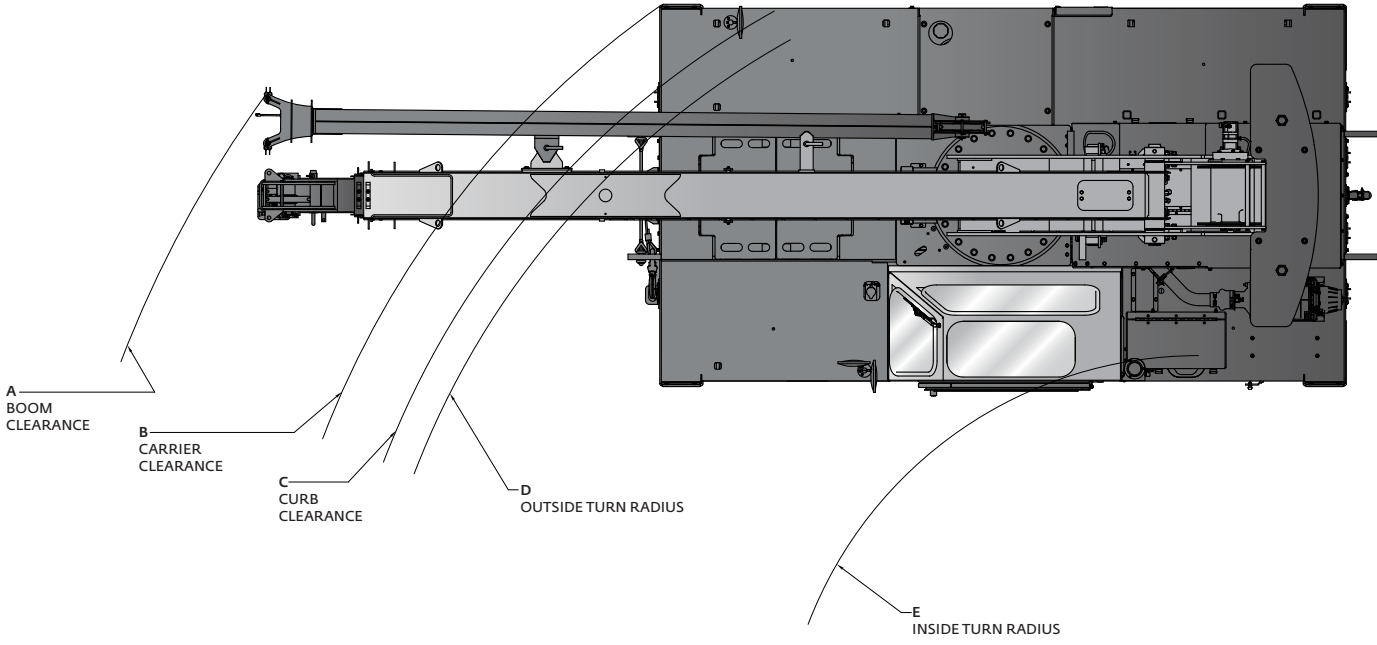
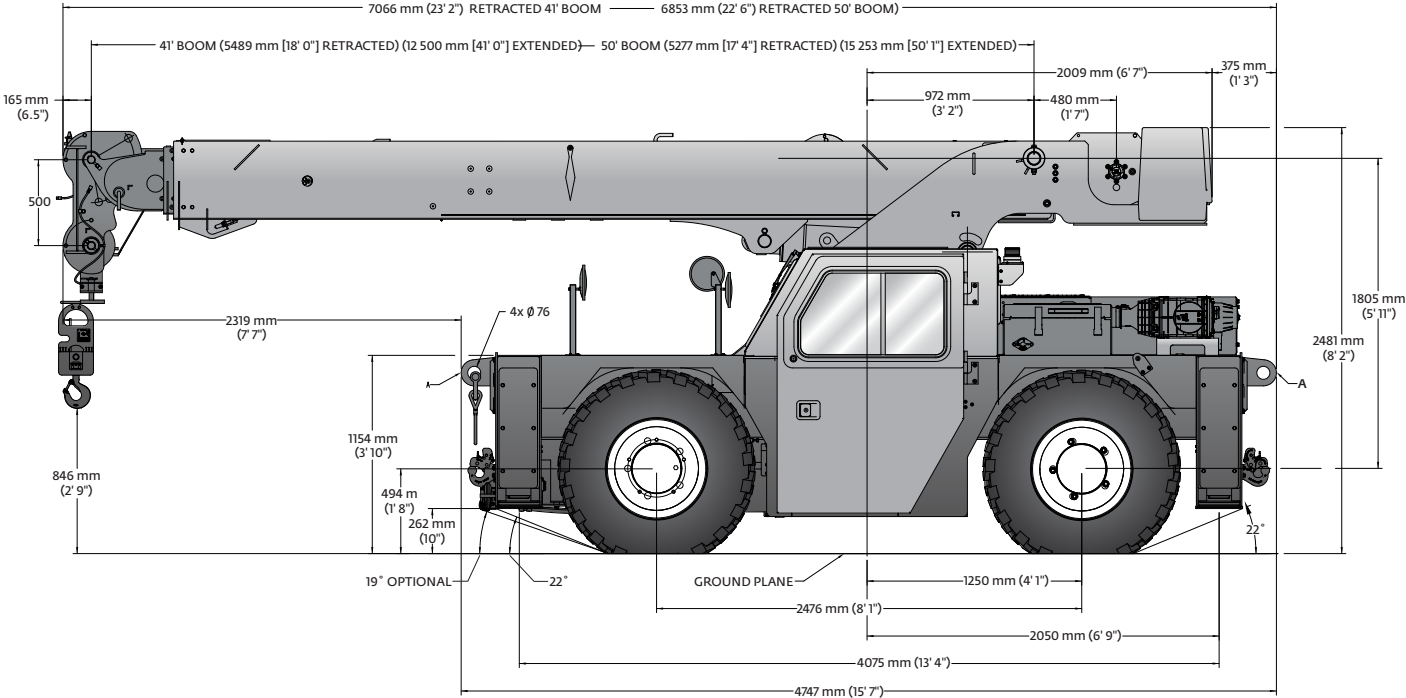

Dimensions and weights

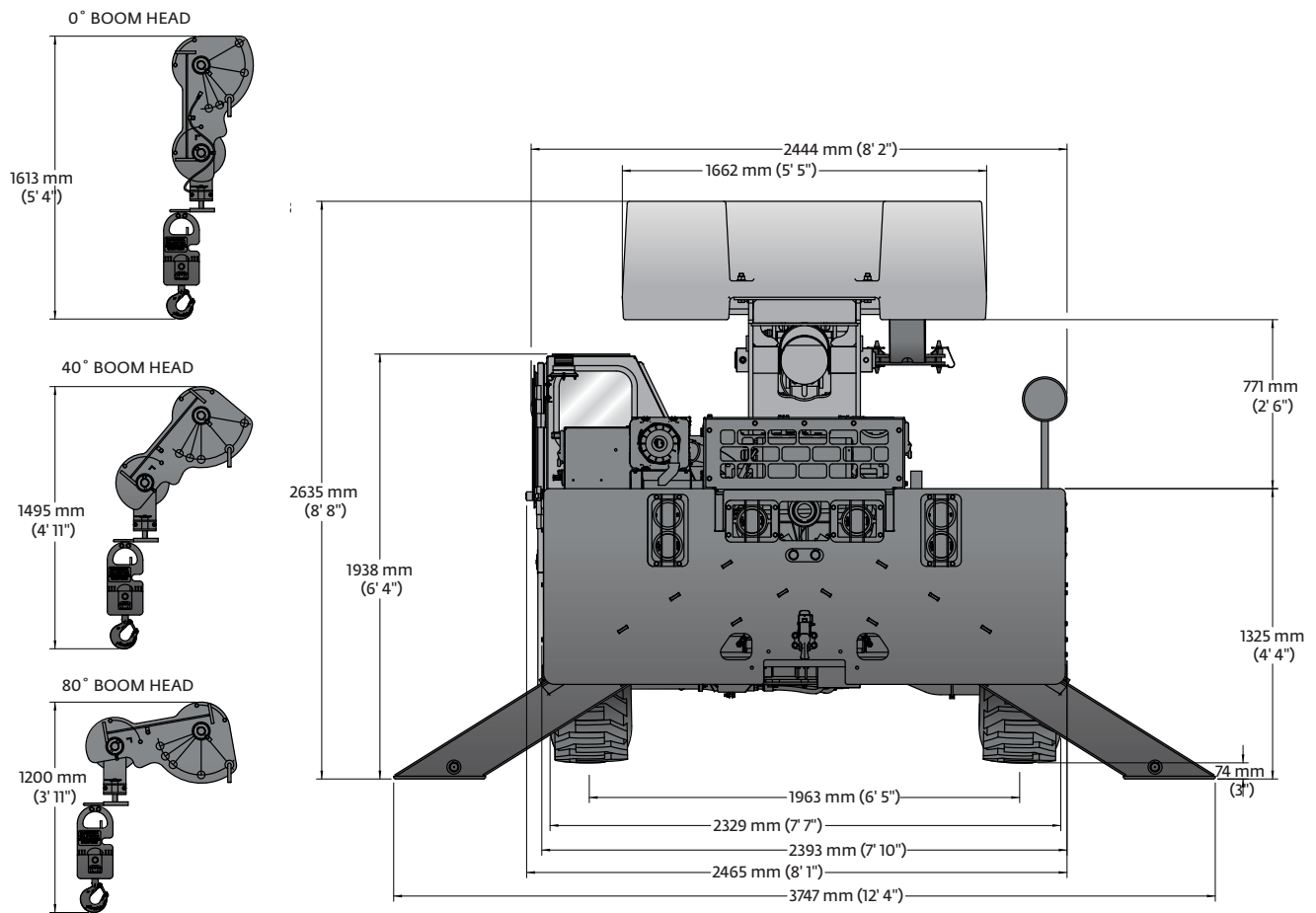

Weights						
	GVW		Front		Rear	
	kg	lb	kg	lb	kg	lb
Basic machine: including 12,5 m (41.0 ft) main boom, hoist with 72 m (235 ft) of wire rope, 18 t (20 USt) hook block, counterweight, Tier 4 engine, and driver.	11 489	25,329	5328	11,747	6161	13,582
Add: 4,6 m (15 ft) fixed swingaway extension and extension carrier brackets and downhaul weight.	245	540	375	828	-130	-287
Crane weight	11 734	25,869	5704	12,574	6030	13,295
Basic machine: including 12,5 m (41.0 ft) main boom, main hoist with 72 m (235 ft) of wire rope, 18 t (20 USt) hook block, full counterweight, Tier 4 engine, and driver.	11 489	25,329	5328	11,747	6161	13,582
Add: Enclosed cab with heater and defroster.	89	196	41	90	48	106
Crane weight	11 578	25,525	5369	11,838	6209	13,687

Working range

41 ft boom - Imperial 85%

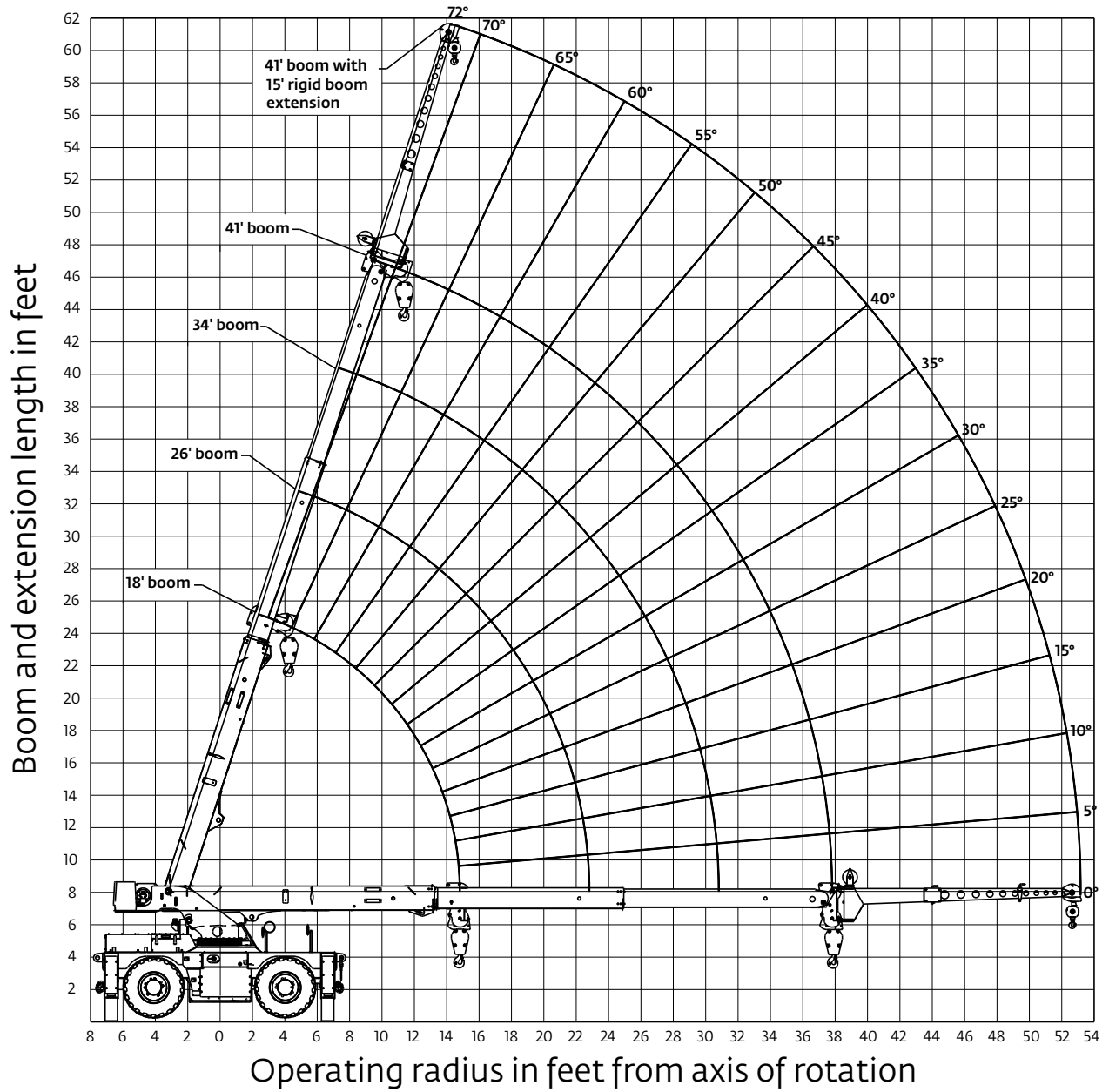

*THIS CHART IS ONLY A GUIDE AND SHOULD NOT BE USED TO OPERATE THE CRANE.
The individual crane's load chart, operating instructions and other instructional plates must be read and understood prior to operating the crane*

Load chart

41 ft boom - Imperial 85%



18 ft - 41 ft



100%



360°



18 ft - 41 ft



100%



Over front



Pounds



Pounds

Radius in Feet	Main Boom Length in Feet			
	18	26	34	41
6	30,000 (66)			
8	27,150 (58.5)	19,800 (69.5)		
10	24,000 (50)	19,800 (64.5)		
12	21,500 (39.5)	18,950 (59.5)	17,350 (67.5)	
14	16,000 (24.5)	16,300 (53.5)	15,150 (64)	13,550 (69)
14.5	13,800 (18.5)	15,300 (52)	14,750 (63)	13,200 (68)
16		12,850 (47.5)	12,750 (60)	12,200 (66)
18		10,500 (40.5)	10,450 (56)	10,800 (62.5)
20		8870 (32)	8800 (51.5)	9070 (59.5)
22		7610 (20)	7550 (46.5)	7760 (56)
22.5		7350 (14.5)	7290 (45.5)	7480 (55)
24			6580 (41.5)	6740 (52.5)
26			5790 (35.5)	5930 (48.5)
28			5140 (28)	5260 (44.5)
30			4610 (17)	4690 (40)
30.5			4490 (12.5)	4570 (39)
32				4220 (35)
34				3810 (29.5)
36				3450 (21.5)
37.5				3220 (11.5)

NOTE: () Boom angles are in degrees. 80101697

Radius in Feet	Main Boom Length in Feet			
	18	26	34	41
6	30,000 (66)			
8	27,150 (58.5)	19,800 (69.5)		
10	24,000 (50)	19,800 (64.5)		
12	21,500 (39.5)	18,950 (59.5)	17,350 (67.5)	
14	18,500 (24.5)	16,700 (53.5)	15,150 (64)	13,550 (69)
14.5	13,800 (18.5)	16,250 (52)	14,750 (63)	13,200 (68)
16		14,900 (47.5)	13,600 (60)	12,200 (66)
18		13,200 (40.5)	12,300 (56)	11,000 (62.5)
20		11,100 (32)	10,900 (51.5)	10,100 (59.5)
22		9560 (20)	9390 (46.5)	9320 (56)
22.5		8960 (14.5)	9070 (45.5)	9140 (55)
24			8210 (41.5)	8360 (52.5)
26			7280 (35.5)	7350 (48.5)
28			6510 (28)	6530 (44.5)
30			5880 (17)	5860 (40)
30.5			5740 (12.5)	5710 (39)
32				5290 (35)
34				4790 (29.5)
36				4370 (21.5)
37.5				4090 (11.5)

NOTE: () Boom angles are in degrees. 80101696

THIS CHART IS ONLY A GUIDE AND SHOULD NOT BE USED TO OPERATE THE CRANE.
The individual crane's load chart, operating instructions and other instructional plates must be read and understood prior to operating the crane

Load chart

41 ft boom - Imperial 85%

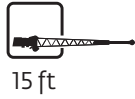

Pounds

NOTES:

1. 15 ft boom extension may be used for single line lifting service only.
2. **WARNING:** Operation of this machine with heavier loads than the capacities listed is strictly prohibited. Machine tipping with boom extension occurs rapidly and without advance warning.

Radius in Feet	15 ft LENGTH		
	0° OFFSET	15° OFFSET	30° OFFSET
18	7370 (70)		
20	7210 (68)		
22	6650 (65.5)	4790 (69.5)	
24	6020 (63.5)	4570 (67)	3650 (70)
26	5590 (61)	4290 (64.5)	3520 (67.5)
28	5290 (58.5)	4120 (62)	3410 (65)
30	4810 (56)	3900 (59.5)	3290 (62.5)
32	4350 (53.5)	3770 (57)	3200 (60)
34	3950 (51)	3600 (54.5)	3120 (57)
36	3600 (48)	3450 (51.5)	3030 (54)
38	3300 (45)	3330 (48.5)	2970 (51)
40	3040 (42)	3080 (45.5)	2910 (47.5)
42	2800 (38.5)	2840 (42)	2850 (44)
44	2590 (35)	2620 (38.5)	2680 (40)
46	2400 (31)	2430 (34.5)	2480 (35.5)
48	2230 (26)	2250 (29.5)	
50	2070 (20.5)	2090 (23)	
52	1930 (11.5)		
52.5	1890 (6.5)		

80101699

THIS CHART IS ONLY A GUIDE AND SHOULD NOT BE USED TO OPERATE THE CRANE.

The individual crane's load chart, operating instructions and other instructional plates must be read and understood prior to operating the crane

Load chart

41 ft boom - Imperial 85%



Radius in Feet	Defined Arc 8° Over Front	Stationary 360°
6	19,300	14,450
8	15,600	11,100
10	12,950	8940
12	10,100	7290
14	7780	5720
14.5	7340	5400
16	6440	4700
18	5340	3890
20	4520	3270
22	3870	2780
22.5	3730	2670
24	3390	2460
26	2960	2140
28	2600	1870
30	2300	1640
30.5	2230	1590
32	2100	1450
34	1870	1280
36	1670	1130
37.5	1540	1030

80101698

1. Capacities are in pounds and do not exceed 75% of tipping loads as determined by test in accordance with SAE J765.
2. Capacities are applicable to machines equipped with outrigger R4 385/65 D22.5 at 125 psi cold inflation pressure.
3. Capacities are applicable only with machine on a smooth, level and firm surface.
4. Defined Arc - Over front includes 8° on either side of longitudinal centerline of machine.
5. All rubber lifting depends on proper tire inflation, capacity and condition. Capacities must be reduced for lower tire inflation pressures. Damaged tires are hazardous to safe operation of crane.
6. For pick and carry operation, the boom, using the shortest practical boom length, must be centered over front of machine. Maximum speed is 2.5 mph.
7. On rubber lifting with boom extension not permitted.

THIS CHART IS ONLY A GUIDE AND SHOULD NOT BE USED TO OPERATE THE CRANE.

The individual crane's load chart, operating instructions and other instructional plates must be read and understood prior to operating the crane

Working range

50 ft boom - Imperial 85%

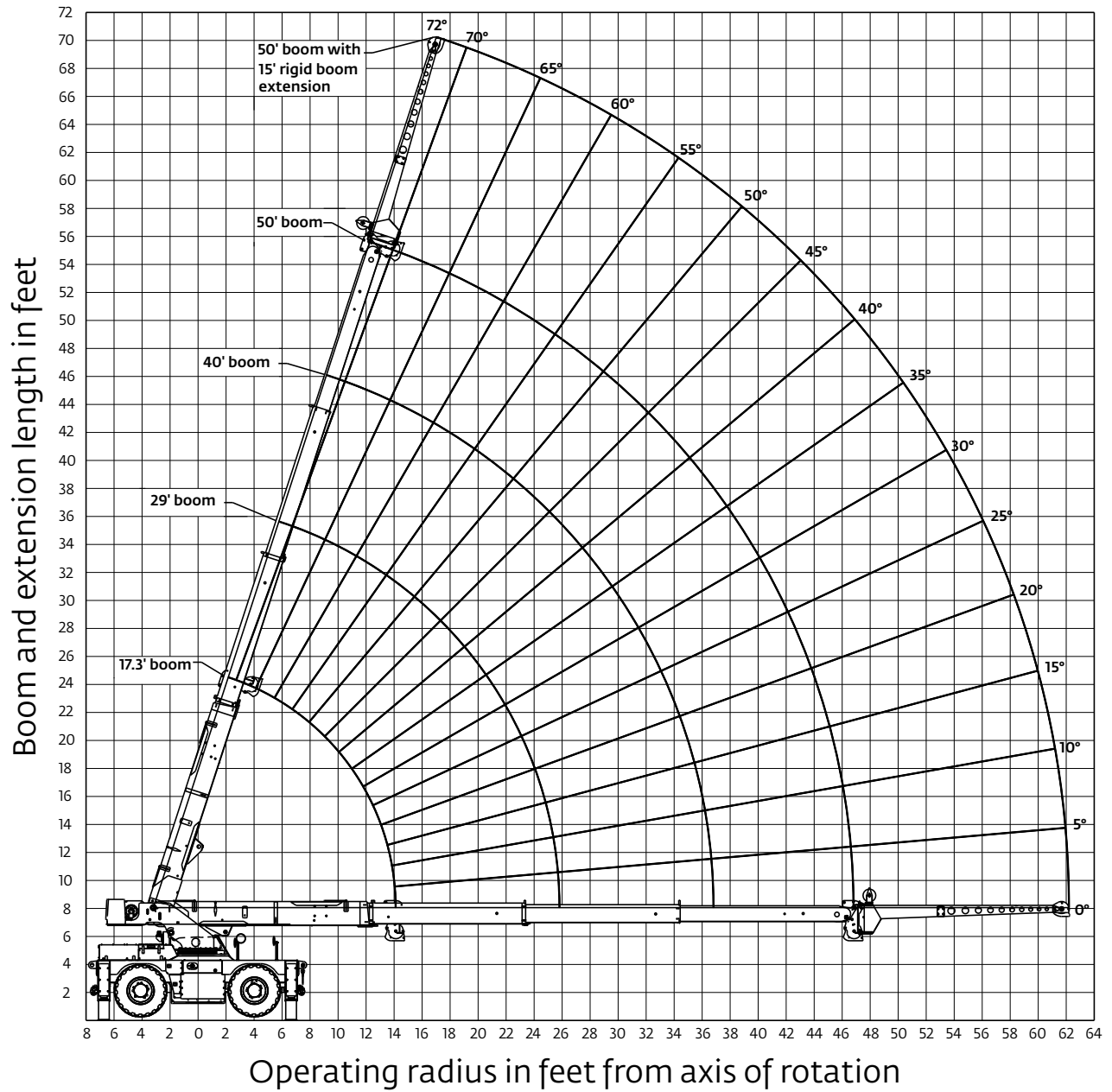

THIS CHART IS ONLY A GUIDE AND SHOULD NOT BE USED TO OPERATE THE CRANE.
 The individual crane's load chart, operating instructions and other instructional plates must be read and understood prior to operating the crane

Load chart

50 ft boom - Imperial 85%



17 ft - 50 ft



100%



360°



17 ft - 50 ft



100%



Over front



Pounds



Pounds

Radius in Feet	Main Boom Length in Feet			
	17.3	29	40	50
6	30,000 (64.5)			
8	25,750 (56.5)			
10	21,250 (47)	16,950 (67)		
12	18,050 (35.5)	16,950 (62.5)		
14	13,100 (15)	15,700 (58)	14,950 (68.5)	
16		12,300 (53)	12,550 (65)	
18		10,050 (48)	10,200 (62)	10,150 (68.5)
20		8470 (42.5)	8550 (58.5)	8500 (65.5)
22		7240 (35)	7300 (55)	7260 (63)
24		6290 (26)	6330 (51.5)	6300 (60.5)
25.5		5700 (14)	5730 (48.5)	5710 (58.5)
26			5550 (47.5)	5530 (57.5)
28			4910 (43)	4900 (55)
30			4380 (38.5)	4370 (52)
32			3920 (33)	3930 (48.5)
34			3530 (26)	3550 (45.5)
36			3190 (16.5)	3220 (42)
36.5			3110 (12)	3140 (41)
38				2930 (38)
40				2670 (34)
42				2440 (29)
44				2230 (23)
46				2040 (14)
46.5				2000 (10)

NOTE: () Boom angles are in degrees. 80101703

Radius in Feet	Main Boom Length in Feet			
	17.3	29	40	50
6	30,000 (64.5)			
8	25,750 (56.5)			
10	21,250 (47)	16,950 (67)		
12	18,050 (35.5)	16,950 (62.5)		
14	13,100 (15)	16,400 (58)	14,950 (68.5)	
16		14,950 (53)	13,700 (65)	
18		13,550 (48)	12,500 (62)	12,150 (68.5)
20		11,200 (42.5)	10,850 (58.5)	10,900 (65.5)
22		9480 (35)	9220 (55)	9250 (63)
24		8140 (26)	7970 (51.5)	7980 (60.5)
25.5		7150 (14)	7210 (48.5)	7210 (58.5)
26			6980 (47.5)	6980 (57.5)
28			6180 (43)	6170 (55)
30			5520 (38.5)	5500 (52)
32			4970 (33)	4940 (48.5)
34			4490 (26)	4460 (45.5)
36			4070 (16.5)	4050 (42)
36.5			3980 (12)	3960 (41)
38				3690 (38)
40				3380 (34)
42				3090 (29)
44				2840 (23)
46				2610 (14)
46.5				2560 (10)

NOTE: () Boom angles are in degrees. 80101702

THIS CHART IS ONLY A GUIDE AND SHOULD NOT BE USED TO OPERATE THE CRANE.
The individual crane's load chart, operating instructions and other instructional plates must be read and understood prior to operating the crane

Load chart

50 ft boom - Imperial 85%

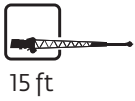

Pounds

Radius in Feet	15 ft LENGTH		
	0° OFFSET	15° OFFSET	30° OFFSET
20	7020 (71.5)		
22	6200 (69.5)		
24	5670 (67.5)	4980 (71.5)	
26	5250 (65.5)	4680 (69)	3720 (71.5)
28	5000 (63.5)	4520 (67)	3600 (69.5)
30	4660 (61.5)	4210 (65)	3500 (67.5)
32	4180 (59.5)	3940 (62.5)	3410 (65.5)
34	3770 (57.5)	3800 (60.5)	3320 (63)
36	3420 (55)	3490 (58.5)	3230 (61)
38	3110 (53)	3150 (56)	3160 (58.5)
40	2830 (50.5)	2860 (54)	2970 (56)
42	2590 (48)	2600 (51.5)	2690 (53.5)
44	2370 (45.5)	2360 (49)	2450 (51)
46	2180 (43)	2150 (46)	2230 (48.5)
48	2000 (40)	1960 (43.5)	2030 (45.5)
50	1840 (37)	1790 (40.5)	1850 (42)
52	1690 (34)	1630 (37)	1680 (38.5)
54	1560 (30.5)	1480 (33.5)	1530 (34.5)
56	1430 (26.5)	1350 (29.5)	1390 (30)
58	1320 (21.5)	1230 (24)	
60	1210 (15)	1110 (17)	
61.5	1140 (6)		

NOTES:

1. 15 ft boom extension may be used for single line lifting service only.
2. WARNING: Operation of this machine with heavier loads than the capacities listed is strictly prohibited. Machine tipping with boom extension occurs rapidly and without advance warning.

80101705

THIS CHART IS ONLY A GUIDE AND SHOULD NOT BE USED TO OPERATE THE CRANE.
The individual crane's load chart, operating instructions and other instructional plates must be read and understood prior to operating the crane

Load chart

50 ft boom - Imperial 85%



17 ft - 50 ft



Stationary



Defined arc
over front



Stationary



360°



Pick & Carry



Over front



Pounds

Radius in Feet	Defined Arc 8° Over Front	Stationary 360°
6	16,000	12,000
8	13,600	9900
10	11,700	8490
12	9820	7220
14	7410	5540
16	6520	4650
18	5340	3800
20	4460	3160
22	3770	2650
24	3220	2240
25.5	2870	1980
26	2850	1960
28	2470	1720
30	2140	1470
32	1870	1260
34	1620	1080
36	1410	910
36.5	1360	880
38	1320	780
40	1150	650
42	1000	540
44	870	430
46	750	340
46.5	720	320

80101704

1. Capacities are in pounds and do not exceed 75% of tipping loads as determined by test in accordance with SAE J765.
2. Capacities are applicable to machines equipped with outrigger R4 385/65 D22.5 at 125 psi cold inflation pressure.
3. Capacities are applicable only with machine on a smooth, level and firm surface.
4. Defined Arc - Over front includes 8° on either side of longitudinal centerline of machine.
5. All rubber lifting depends on proper tire inflation, capacity and condition. Capacities must be reduced for lower tire inflation pressures. Damaged tires are hazardous to safe operation of crane.
6. For pick and carry operation, the boom, using the shortest practical boom length, must be centered over front of machine. Maximum speed is 2.5 mph.
7. On rubber lifting with boom extension not permitted.

THIS CHART IS ONLY A GUIDE AND SHOULD NOT BE USED TO OPERATE THE CRANE.

The individual crane's load chart, operating instructions and other instructional plates must be read and understood prior to operating the crane

Transportation and lifting data

TRANSPORTATION AND LIFTING DATA

1. LIFTING OF ENTIRE CRANE OR MAJOR CRANE ASSEMBLIES MUST BE ACCOMPLISHED BY UTILIZING SPECIFIC FITTINGS INDICATED ON ADJACENT CHART. USE OF FITTINGS FOR PURPOSES OTHER THAN THOSE DESIGNATED ON CHART IS PROHIBITED. FITTING CAPACITIES ARE MAXIMUM ALLOWABLE LOADS PER INDIVIDUAL FITTING.
2. RIGGING PERSONNEL SHALL BE RESPONSIBLE FOR PROPER SELECTION AND PLACEMENT OF ALL SLINGS AND LOAD HANDLING DEVICES.
3. DIMENSIONS AND WEIGHTS SHOWN ARE ESTIMATED FOR LARGEST CONFIGURATION AVAILABLE. WEIGHTS DO NOT INCLUDE BOOM EXTENSION AND OR JIB, UNLESS OTHERWISE INDICATED.
4. RIGGING PERSONNEL SHALL VERIFY DIMENSIONS AS REQUIRED FOR CLEARANCE.
5. DO NOT USE COUNTERWEIGHT LIFT LOCATIONS OR BOOM SLING POINT FOR LIFTING OR TIE DOWN OF ENTIRE CRANE.
6. LIFTING OF COUNTERWEIGHT TO BE ACCOMPLISHED WITH A PROPERLY RATED 1 1/4"-7 UNC FITTINGS.

FITTING	NO. / UNIT				BOOM	CWT	CAPACITY-TONNES [TONS]				
		LIFT	TOW	TIE DOWN			LIFT	LIFT	TIE DOWN		
									LIFT	TOW	FORE & AFT
A	4	X	X	X			25.4 [28]	25.4 [28]	25.4 [28]	7.3 [8]	25.4 [28]
B	4				X		1.8 [2]				
C	2					X	1.7 [1.9]				

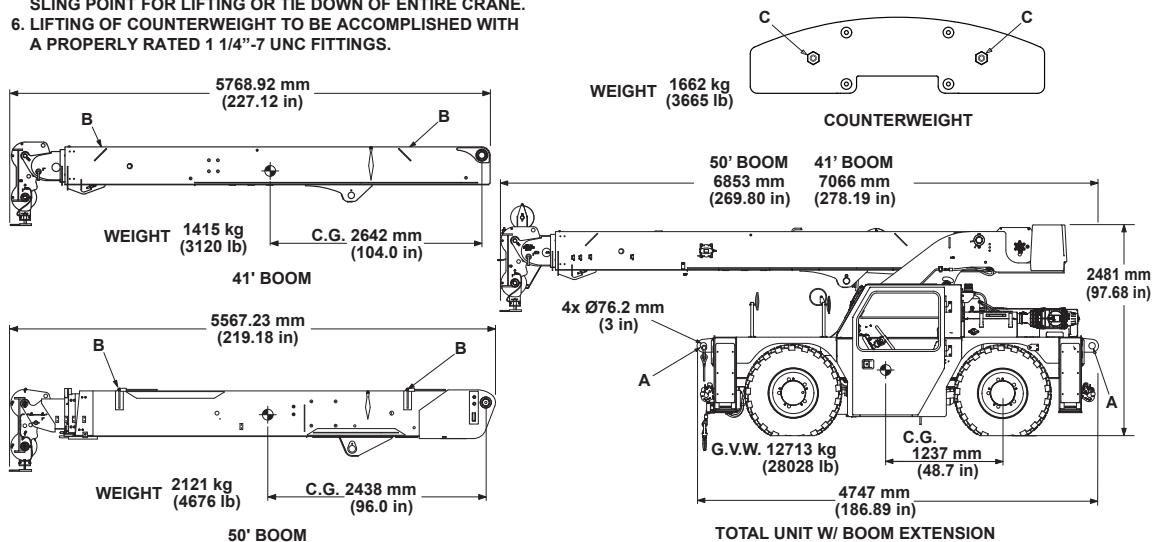

LOAD DISTRIBUTION FOR CARRYDECK

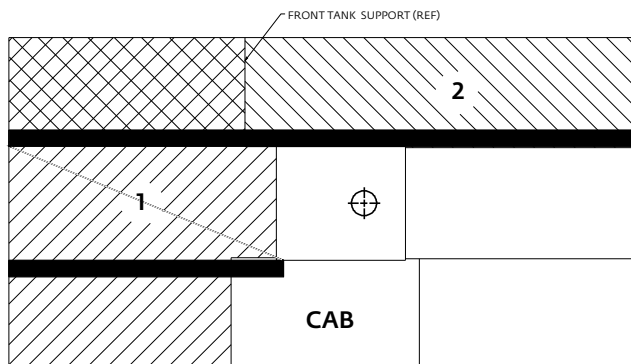

Maximum allowable uniformly distributed load:

AREA 1
8165 kg (18,000 lb)

OR

AREA 2
5897 kg (13,000 lb)

1. Maximum travel speed with any or all loads - 4,0 kmh (2.5 mph)
2. Loads to be transported on smooth level firm surfaces only.
3. Boom must be retracted and in center forward position, and lowered as much as the load allows.
4. Pick and carry loads may be transported on either Deck Area 1 or Deck Area 2; combined loading of Deck Area 1 and Deck Area 2 not permitted.
5. Lifting is not permitted when carrydeck is loaded except for loading and unloading carrydeck.
6. The maximum pick and carry loads may be transported on deck area 1 provided the load is centered over the front axle and cribbed directly on the frame rails.

Load handling

WEIGHT REDUCTIONS FOR LOAD HANDLING DEVICES

4,6 m (15 ft) FIXED OFFSETTABLE EXTENSION	
*Stowed	N/A
*Erected	295 kg (650 lb)

*Reduction of main boom capacities

When lifting over swingaway and/or jib combinations, deduct total weight of all load handling devices reeved over main boom nose directly from swingaway or jib capacity.

HOOK BLOCKS AND HEADACHE BALLS	
18 t (20 USt), two-sheave hook block	176 kg (388 lb)+
5,7 t (6.25 USt) downhaul weight	48 kg (105 lb)+

+Refer to rating plate for actual weight

NOTE: All load handling devices and boom attachments are considered part of the load and suitable allowances MUST BE MADE for their combined weights. Weights are for Shuttlelift furnished equipment.

TIRE INFLATION - BAR (PSI)		
SIZE (FRONT & REAR)	PLY RATING	LIFTING SERVICE, GENERAL TRAVEL & EXTENDED TRAVEL
		STATIC & 4,0 KMH (2.5 MPH)
OUTRIGGER R4 385/65 D22.5	16	8,6 (125)

LIFTING AREA DIAGRAM

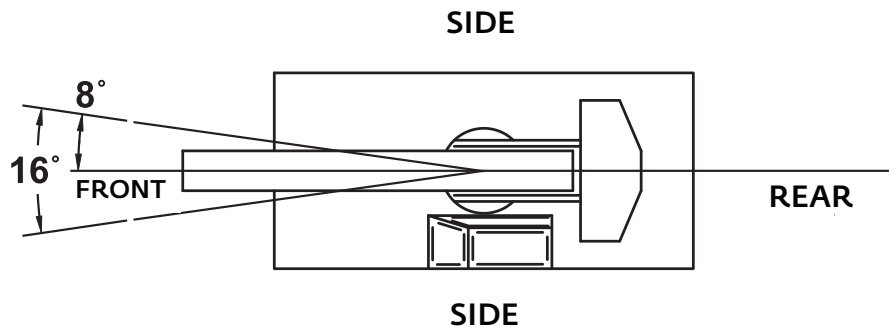

LINE PULLS AND REEVING INFORMATION

HOISTS	CABLE SPECS.	PERMISSIBLE LINE PULLS	NOMINAL CABLE LENGTH
Main (41 ft boom)	14 mm (9/16") 6x19 class Bridon EEIPS (XXIPS) Min. breaking strength 16,780 kg (37,000 lb)	3856 kg (8500 lb)*	72 m (235 ft)
Main (50 ft boom)	14 mm (9/16") 6x19 class Bridon EEIPS (XXIPS) Min. breaking strength 16,780 kg (37,000 lb)	3856 kg (8500 lb)*	84.7 m (278 ft)

The approximate weight of 14 mm (9/16") wire rope is 0,9 kg/m (0.59 lb/ft).

*With certain boom and hoist tackle combinations, the allowable line pull may be limited by hoist performance. Refer to hoist performance table for lift planning to ensure adequate hoist performance on drum rope layer required.

Specifications

Superstructure



Boom

5,5 m – 12,5 m (18 ft - 41 ft) full-power main boom. Three-section boom with two (2) powered sections.

Maximum tip height: 14,2 m (46.5 ft).



*Optional boom

5,3 m – 15,2 m (17.3 ft - 50 ft) full-power main boom. Four-section boom with three (3) powered sections.

Maximum tip height: 16,5 m (54 ft).



Optional swingaway extension

4,6 m (15 ft) offsettable swingaway extension. Offsets 0°, 15° and 30° via pivoting boom nose. Stows alongside base boom section.

Maximum tip height: 21,18 m (69.5 ft).



Boom nose

Nylatron sheaves mounted on heavy-duty needle roller bearings with removable pin-type rope guards. Quick reeve type boom nose with three-position (0°, +40°, and + 80°) pivoting to minimize head height requirements. Lowers head height by 0,4 m (1.3 ft).



Boom elevation

Single double acting hydraulic cylinders with integral holding valves provides elevation from 0° to +72°.



Anti-two block device

Standard anti-two block device, which, when activated, provides an audible warning to the operator and "locks-out" all functions whose movement can cause two-blocking.



Rated Capacity Limiter (RCL)

Full-color, graphical display of boom angle, boom length, boom radius, rated load, and calculated load. Allows for operator inputs to set the crane configuration. RCL system is hardwired and calculates load via pressure transducers in the lift cylinder. Display includes a color-coded light bar and audible alarm with function cut-out if load exceeds the load chart parameters.



Swing

Ball bearing swing circle with 360° continuous rotation. Worm gear and pinion driven by hydraulic motor.

Maximum speed: 2,0 rpm



Hydraulic system

One pressure compensated variable displacement axial piston pump with load sensing.

Maximum output of: 130,6 lpm (34.5 gpm).

Maximum operating pressure: 241 bars (3500 psi).

Four-section valve bank, chassis mounted, operated via dash mounted, hydraulic pilot controls. 130,6 L (34.5 gal) hydraulic reservoir with sight level gauge and steel side plating to guard against side impacts.

5 micron return line filter with full flow by-pass protection and service indicator.



Hoist specifications

Geroler motor driven with automatic spring-applied / hydraulically released wet brake. Drum rotation indicator in the hoist joystick control and hoist direction indicator light on dashboard.

Maximum hoist pull (first layer): 4282 kg (9440 lb)

Maximum permissible single line pull: 3856 kg (8500 lb)
(3.5:1 design factor)

Maximum single line speed: 35,66 m/min (117 fpm)

Rope construction: 6X19 EEIPS/IWRC

Rope diameter: 14 mm (9/16 in)

Rope length: Main hoist 12,5 m (41 ft) boom: 72 m (235 ft)
Main hoist 15,2 m (50 ft) boom: 84,7 m (278 ft)

Maximum rope stowage: Main hoist: 90,83 m (298 ft)

Carrier



Chassis

High-strength alloy frame constructed with integral outrigger housings; front and rear lifting, tie-down, and towing lugs. 5,57 m² (60 ft²) carrydeck size with 8165 kg (18,000 lb) deck only carrying capacity. Deck coated with anti-skid treatment.



Outriggers

Hydraulically powered oblique-style single-stage outriggers that are independently controlled using the main control valve that provides 10,16 cm (4 in) of lift off the ground for leveling the crane. Outrigger cylinders have an integral holding valve.

Outrigger pad size:

27,3 cm x 40,64 cm (10.75 in x 16 in)

Maximum outrigger pad load:

13 608 kg (30,000 lb)



Outrigger controls

Independent outrigger controls. 360° bubble level located inside cab.



Engine (EPA Tier 4F)

Cummins QSF 3.8L, four-cylinder / turbo-charged diesel rated at 55.1 kW (74 hp) at 2200 rpm. Standard 120 V engine block heater and cold weather intake grid heater. Engine hour meter located in dash display. Alternator 145 amp.

Complies with EPA Tier 4 Final emissions standards without the use of an SCR or UREA injected DEF system.

Maximum torque: 399,9 N-m (295 ft lb) at 1300 rpm.

Note: Tier 4F engine required in North American countries.

Fuel requirements: Maximum of 15 ppm ultra-low sulfur diesel fuel

**Denotes optional equipment*

Specifications



Engine (EPA Tier 3)

*Please consult factory for availability.

Cummins QSF 3,8L, four-cylinder / turbo-charged diesel rated at 74 kW (99 hp) at 2200 rpm. Standard 120 V engine block heater and cold weather intake grid heater. Engine hour meter located in dash display. Alternator 135 amp.

Maximum torque: 420,3 Nm (310 ft/lb).

Note: Required for sale outside of North American and European Union countries.



Engine (Dual Fuel)

GM 4.3L EFI V-6 gasoline 90.3 HP @ 2200 rpm / LP gas engine (07 EPA) 75.1 HP @ 2200 rpm (LP tank not included) with engine shutdown feature and spark arrestor.



Fuel tank capacity

100 L (26.4 gal)



Transmission

Powershift with four speeds forward and three speeds reverse. Stalk mounted direction shifter with rotary gear selection.



Operators control station

Frame mounted, open air style control station with cab shell includes all crane functions, driving controls, and overhead safety glass. Other standard equipment includes a deluxe seat with seat belt, hour meter, sight level bubble, and 1,13 kg (2.5 lb) fire extinguisher.

The dash panel includes a multi-cluster gauge showing fuel, water temperature, battery voltage and engine fault codes. An engine monitoring indicator lamp shows engine warning, stop engine, wait to start, transmission high temperature, low brake system pressure, and hydraulic oil temperature. The RCL display is mounted to the top of the front dash.



*Operators control station enclosed

Includes the standard cab shell with the addition of front, rear, and right side glass, a split (2 piece) hinged door with sliding glass, front windshield wiper and washer, hot water heater and defroster with fan and cab dome light are included.



Electrical system

One 12 V maintenance-free battery, 1125 CCA each at 0°. 135 amp alternator.



Drive

Two-wheel (front-wheel) as standard with four-wheel drive as an option. Drive axles supplied with planetary hubs and limited slip differential.



Steering

Standard three steering modes. Front two-wheel, four-wheel coordinated, and four-wheel crab steer with electronic self alignment, three-position rocker selector on dash panel.

Outside turning radius:

Two-wheel steer: 5,32 m (17 ft 5.37 in)

Four-wheel steer: 2,86 m (9 ft 4.44 in)



Axles

Front: Drive/steer in both two-wheel drive and four-wheel drive

Rear: Non-drive with steer in two-wheel drive, drive/steer in four-wheel drive

Front and rear axle are rigid mounted to frame. Rear axle offers 1.5° of oscillation with four-wheel drive option only.



Brakes

Hydraulic actuated internal wet-disc service brake acting on all four wheels. Dash mounted toggle switch with light for activating or release of the dry disc parking brake mounted on the transmission output yoke.



Tires

Standard: 385/65R 22.5 High traction tread radial type tires



Light

Full lighting including turn indicators, head, tail, brake and hazard warning lights recessed mounted.



Maximum speed

25.75 km/h (16 mph)



Gradeability (theoretical)

40%.....(at engine stall) loaded

Gross vehicle weight (GVW)

Open cab: 11 285 kg (24,877 lb)

Enclosed cab: 11 412 kg (25,160 lb)

Miscellaneous standard equipment



































- 18,14 t (20 USt) quick-reeve, two-sheave hook block
- Back-up motion alarm
- Outrigger motion alarm
- Hoist drum rotation indicator

*Optional equipment

- Auxiliary lighting: includes amber strobe light and boom mounted work lights
- Convenience package: includes front and rear pintle hitch and headlight/taillight grille covers
- Enclosed cab package: includes heater and defroster, cab dome light, all window glass, and two-piece split door
- Offsetable swing away boom extension with hook and downhaul weight
- Air conditioner
- Wire rope third wrap indicator with hoist function cut-out
- 4535 kg (10,000 lb) capacity hydraulic below-deck mounted tow winch
- Four-wheel drive with 1.5° rear axle oscillation
- Searcher hook

**Denotes optional equipment*

Symbols glossary

 Axles	 Drive	 Hoist	 Rated Capacity Limiter (RCL)
 Boom	 Electrical system	 Hook block	 Rotation
 Boom elevation	 Engine	 Hydraulic system	 Speed
 Boom extension	 Extension	 Insert	 Steering
 Boom length	 Frame	 Lights	 Suspension
 Boom nose	 Fuel tank capacity	 Oil	 Swing
 Brakes	 Gear	 Outrigger controls	 Tires
 Cab	 Grade	 Outriggers	 Transmission
 Counterweight	 Heavy-duty jib	 Radius	

The Manitowoc Company, Inc.

Regional headquarters

Americas

Milwaukee, Wisconsin, USA
Tel: +1 414 760 4600

Shady Grove, Pennsylvania, USA
Tel: +1 717 597 8121

Europe and Africa

Dardilly, France - TOWERS
Tel: +33 (0) 4 72 18 20 20

Wilhelmshaven, Germany - MOBILE
Tel: +49 (0) 4421 294 0

APAC

Shanghai, China
Tel: +86 21 6457 0066

Singapore
Tel: +65 6264 1188

Middle East and India

Dubai, UAE
Tel: +971 4 8862677

This document is non-contractual. Constant improvement and engineering progress make it necessary that we reserve the right to make specification, equipment, and price changes without notice. Illustrations shown may include optional equipment and accessories and may not include all standard equipment.

